



SACD/CD Player



MCD301 Owner's Manual



The lightning flash with arrowhead, within an equilateral triangle, is intended to alert the user to the presence of uninsulated “dangerous voltage” within the product’s enclosure that may be of sufficient magnitude to constitute a risk of electric shock to persons.



AVIS RISQUE DE CHOC ELECTRIQUE - NE PAS OUVRIR.

The exclamation point within an equilateral triangle is intended to alert the user to the presence of important operating and maintenance (servicing) instructions in the literature accompanying the appliance.

WARNING - TO REDUCE RISK OF FIRE OR ELECTRICAL SHOCK, DO NOT EXPOSE THIS EQUIPMENT TO RAIN OR MOISTURE.

NO USER-SERVICEABLE PARTS INSIDE. REFER SERVICING TO QUALIFIED PERSONNEL.

To prevent the risk of electric shock, do not remove cover or back. No user-serviceable parts inside.

CAUTION - Invisible Laser Radiation when open. DO NOT stare into the beam or view directly with optical instruments. Use of controls or adjustments or performance of procedures other than those specified in the Owners Manual may result in Hazardous Radiation Exposure.

**LUOKAN 1 LASERLAITE
KLASS 1 LASER APPARAT**

VAROITUS! Laitteen käyttäminen muulla kuin tassa käyttöohjeessa mainitulla tavalla saattaa altistaa käyttäjän turvallisuusluokan 1 ylittävälle näkymättömälle lasersäteilylle.

WARNING! Om apparaten används på annat sätt än i denna bruksanvisning specificerats, kan användaren utsättas för osynlig laserstrålning, som överskrider gränsen för laserklass 1.

This product incorporates an embedded **CLASS 3R Laser (IEC60825-1).**

CAUTION: CLASS 3R INVISIBLE LASER RADIATION WHEN OPEN. DO NOT STARE INTO THE BEAM OR VIEW DIRECTLY WITH OPTICAL INSTRUMENTS. AVOID DIRECT EYE EXPOSURE.

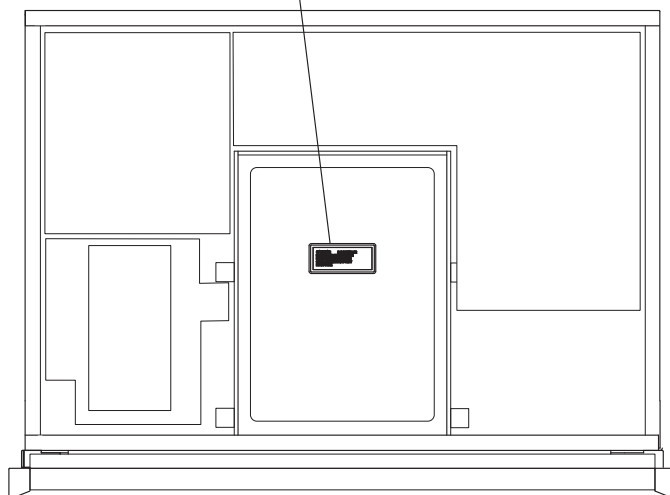

**CLASS 1
LASER PRODUCT**

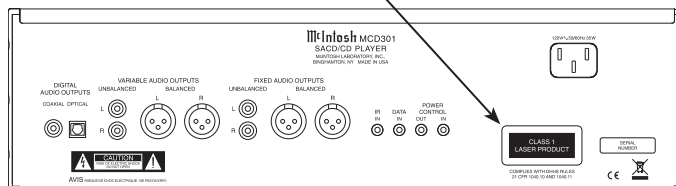

IMPORTANT SAFETY INSTRUCTIONS!

PLEASE READ THEM BEFORE OPERATING THIS EQUIPMENT.

1. Read these instructions.
2. Keep these instructions.
3. Heed all warnings.
4. Follow all instructions.
5. Do not use this apparatus near water.
6. Clean only with a dry cloth.
7. Do not block any ventilation openings. Install in accordance with the manufacturer's instructions.
8. Do not install near any heat sources such as radiators, heat registers, stoves, or other apparatus (including amplifiers) that produce heat.
9. Do not defeat the safety purpose of the polarized or grounding-type plug. A polarized plug has two blades with one wider than the other. A grounding type plug has two blades and a third grounding prong. The wide blade or the third prong are provided for your safety. If the provided plug does not fit into your outlet, consult an electrician for replacement of the obsolete outlet.
10. Protect the power cord from being walked on or pinched particularly at plugs, convenience receptacles, and the point where they exit from the apparatus.
11. Only use attachments/accessories specified by the manufacturer.
12. Use only with the cart, stand, tripod, bracket, or table specified by the manufacturer, or sold with the apparatus. When a cart is used, use caution when moving the cart/apparatus combination to avoid injury from tip-over.
13. Unplug this apparatus during lightning storms or when unused for long periods of time.
14. Refer all servicing to qualified service personnel. Servicing is required when the apparatus has been damaged in any way, such as power-supply cord or plug is damaged, liquid has been spilled or objects have fallen into the apparatus, the apparatus has been exposed to rain or moisture, does not operate normally, or has been dropped.
15. Do not expose this equipment to dripping or splashing and ensure that no objects filled with liquids, such as vases, are placed on the equipment.
16. To completely disconnect this equipment from the a.c. mains, disconnect the power supply cord plug from the a.c. receptacle.
17. The mains plug of the power supply cord shall remain readily operable.
18. Do not expose batteries to excessive heat such as sunshine, fire or the like.





Thank You

Your decision to own this McIntosh MCD301 SACD/CD Player ranks you at the very top among discriminating music listeners. You now have “The Best.” The McIntosh dedication to “Quality,” is assurance that you will receive many years of musical enjoyment from this unit. Please take a short time to read the information in this manual. We want you to be as familiar as possible with all the features and functions of your new McIntosh.

Please Take A Moment

The serial number, purchase date and McIntosh Dealer name are important to you for possible insurance claim or future service. The spaces below have been provided for you to record that information:

Serial Number: _____

Purchase Date: _____

Dealer Name: _____

Technical Assistance

If at any time you have questions about your McIntosh product, contact your McIntosh Dealer who is familiar with your McIntosh equipment and any other brands that may be part of your system. If you or your Dealer wish additional help concerning a suspected problem, you can receive technical assistance for all McIntosh products at:

McIntosh Laboratory, Inc.
2 Chambers Street
Binghamton, New York 13903
Phone: 607-723-1545
Fax: 607-724-0549

Customer Service

If it is determined that your McIntosh product is in need of repair, you can return it to your Dealer. You can also return it to the McIntosh Laboratory Service Department. For assistance on factory repair return procedure, contact the McIntosh Service Department at:

McIntosh Laboratory, Inc.
2 Chambers Street
Binghamton, New York 13903
Phone: 607-723-3515
Fax: 607-723-1917

Copyright 2008 © by McIntosh Laboratory, Inc.

Table of Contents

Safety Instructions	2
Thank You and Please Take a Moment.....	4
Technical Assistance and Customer Service	4
Table of Contents	4
General Information	4
Disc Information.....	5
Connector and Cable Information	5
Introduction.....	6
MCD301 Features	6
Dimensions	7
Installation	8

Connections:

Rear Panel Connections	9
How to Connect Control, Analog and Digital Audio	10
How to Connect Directly to a Power Amplifier	11

Front Panel Features:

Front Panel Displays, Controls, Push-buttons and Jack ..	12
Front Panel Information Displays	13

Remote Control:

Remote Control Push-buttons.....	14
How to Operate by Remote Control	15

Operation:

How to Operate the MCD301	16
---------------------------------	----

Additional Information:

Specifications.....	22
Packing Instruction.....	23

General Information

1. For additional connection information, refer to the owner’s manual(s) for any component(s) connected to the MCD301 SACD/CD Player.
2. The Super Audio Compact Discs Audio Signals are converted internally from Digital to Analog.
3. A PCM version of the decoded MP3 and WMA Signals is available at the Digital Audio Outputs.

Disc Information

1. Compact Discs that are not round (e.g. Novelty discs with octagonal or heart shapes) will not play properly in the MCD301 and should not be tried, as possible damage may occur.
2. The MCD301 SACD/CD Player is designed to play all standard CD Audio Discs that conform to the Official Compact Disc Standards which is indicated by the  Symbol. It will also play most CD-R and CD-RW discs, however some recorded discs may not be able to play due to the condition of the recording.
3. CD Audio Discs recorded in the MP3 and WMA Formats will playback on the MCD301, except discs that contain multi-session recordings. Some MP3 or WMA recorded discs may not be able to play due to the condition of the recording. When ever possible, set the writing software to the ISO9660 Level 1 standard.
4. The CD audio side of the Dual Disc does not meet the Compact Disc Digital Audio specifications found in the industry "Redbook"; the MCD301 may not read Dual Discs.
5. Several of the SACD performance features available on the MCD301 are active only if the SACD Disc includes the supporting encoded information.

Connector and Cable Information

XLR Connectors

Below is the Pin configuration for the XLR Balanced Output Connectors on the MCD301. Refer to the diagram for connection:

- PIN 1: Shield/Ground
- PIN 2: + Output
- PIN 3: - Output

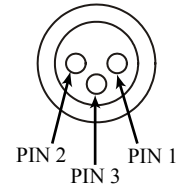

Power Control Connector

The MCD301 Power Control Input/Output Jacks receive/send Power On/Off Signals when connected to other McIntosh Components. A 1/8 inch stereo mini phone plug is used for connection to the Power Control Input/Output on the MCD301.

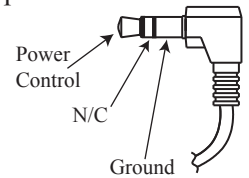

Note: The Data and Power Control Connecting Cable is available from the McIntosh Parts Department:

Data and Power Control Cable Part No. 170-202

Six foot, shielded 2 conductor, with 1/8 inch stereo mini phone plugs on each end.

Data and IR Input Port Connectors

The MCD301 Data In Port receives Remote Control Signals. A 1/8 inch stereo mini phone plug is used for connection. The IR Ports also use a 1/8 inch stereo mini phone plug and allow the connection of other brand IR Receivers to the MCD301.

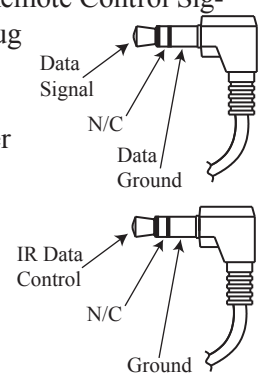



Introduction

The McIntosh MCD301 SACD/CD Player offers the latest in audio technology, providing state of the art reproduction of audio program sources. A full complement of performance features allows for the enjoyment of the SACD special audio format available on discs. Audio CDs are also reproduced with flawless realism. The advanced mechanical design of the transport ensures many years of smooth trouble free operation.

MCD301 Features

• Twin Laser Pickup

The MCD301 incorporates two laser elements, with different wavelengths, that are focused through one lens assembly. This unique design allows reading both the CD and Super Audio Compact Disc (SACD) Discs Formats.

• Advanced Transport

The MCD301 has a new transport with a Die Cast Mechanism Base and Disc Tray. It has the latest in advanced digital servo for faster, quieter and accurate operation. The SACD and CD Audio Data is read into memory from the disc at twice the normal rate. The fast read speeds help to insure better disc tracking and error correction processing.

• Super Audio Disc Playback

The MCD301 plays the higher resolution SACD Discs with extreme precision and musical elegance.

• Multi-Bit Digital to Analog Converter

The 24-bit, 192kHz Digital to Analog Converter has a wide dynamic range and extremely low distortion.

• Front Panel Level Control

With headphones connected to the MCD301, the Level Control allows varying the volume level of the music. It can also be used for matching the volume level of the MCD301 with other components in the system.

• Multi-Function Front Panel Display

The MCD301 Front Panel display indicates the current disc playback status and the variable audio output volume level at the same time on a continuous basis.

• Drive a Power Amplifier Directly

The Variable Output Connections provide up to 6 Volts. This is more than enough signal to drive any Power Amplifier directly; forming a high quality SACD/CD Disc Playback System.

• Balanced Outputs

The MCD301 has both variable and fixed Balanced Outputs, permitting long cable lengths without a loss in sound quality.

• Digital Audio Outputs

There are Coaxial and Optical Digital Outputs for external decoding of the PCM Signal.

• Power Control

The Power Control Input connection provides convenient Turn-On/Off of the MCD301 when connected to a McIntosh System with Power Control. The Power Control Output connection can control a McIntosh Power Amplifier in a high quality disc playback system.

• Full Function Remote Control

The Remote Control provides complete control of the MCD301 operating functions including adjustment of the volume level. The push-buttons on the Remote Control are illuminated.

• Special Power Supply

The Linear Power Supply has both a special R-Core Power Transformer and Multiple Regulators to ensure stable noise free operation even though the power line varies.

• Fiber Optic Solid State Front Panel Illumination

The Illumination of the Glass Front Panel is accomplished by the combination of custom designed Fiber Optic Light Diffusers and extra long life Light Emitting Diodes (LEDs). This provides even Front Panel Illumination and is designed to ensure the pristine beauty of the MCD301 will be retained for many years.

Dimensions

The following dimensions can assist in determining the best location for your MCD301. There is additional information on the next page pertaining to installing the MCD301 into cabinets.

Front View of the MCD301

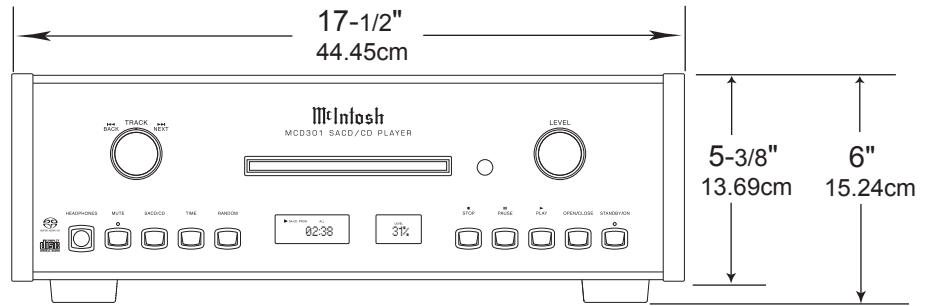

Rear View of the MCD301

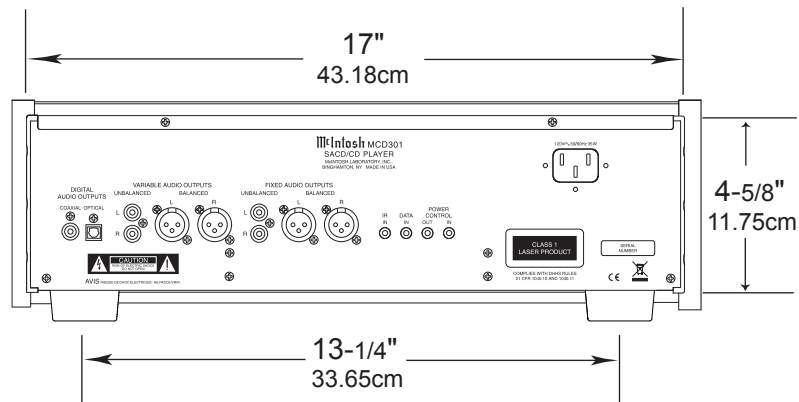

Side View of the MCD301

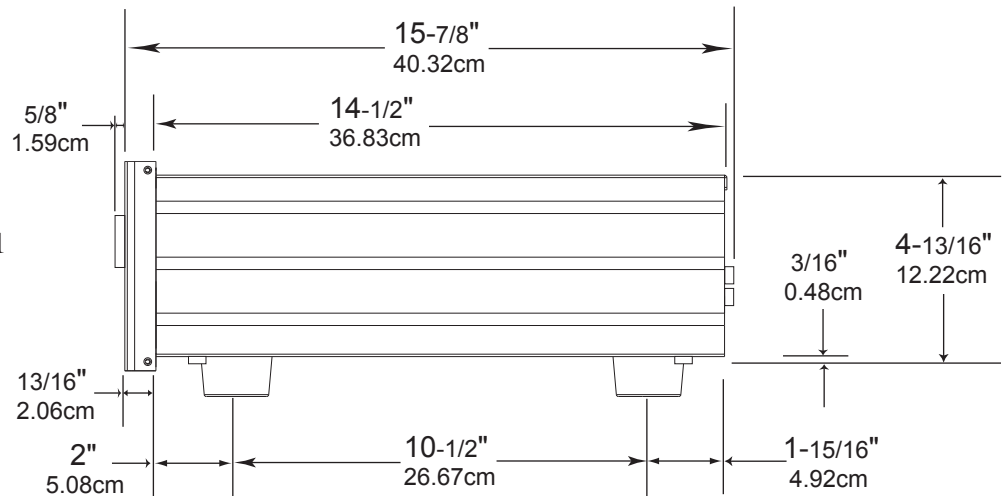

Installation

The MCD301 can be placed upright on a table or shelf, standing on its four feet. It also can be custom installed in a piece of furniture or cabinet of your choice. The four feet may be removed from the bottom of the MCD301 when it is custom installed as outlined below. The four feet together with the mounting screws should be retained for possible future use if the MCD301 is removed from the custom installation and used free standing. The required panel cutout, ventilation cutout and unit dimensions are shown. Always provide adequate ventilation for your MCD301.

Cool operation ensures the longest possible operating life for any electronic instrument. Do not install the MCD301 directly above a heat generating component such as a high powered amplifier. If all the components are installed in a single cabinet, a quiet running ventilation fan can be a definite asset in maintaining all the system components at the coolest possible operating temperature.

A custom cabinet installation should provide the following minimum spacing dimensions for cool operation.

Allow at least 2 inches (5.08cm) above the top, 2 inches (5.08cm) below the bottom and 1 inch (2.54cm) on each side of the SACD/CD Player, so that airflow is not obstructed. Allow 17 inches (43.18cm) depth behind the front panel. Allow 1-1/8 inch (2.9cm) in front of the mounting panel for knob clearance. Be sure to cut out a ventilation hole in the mounting shelf according to the dimensions in the drawing.

MCD301 Front Panel Custom Cabinet Cutout

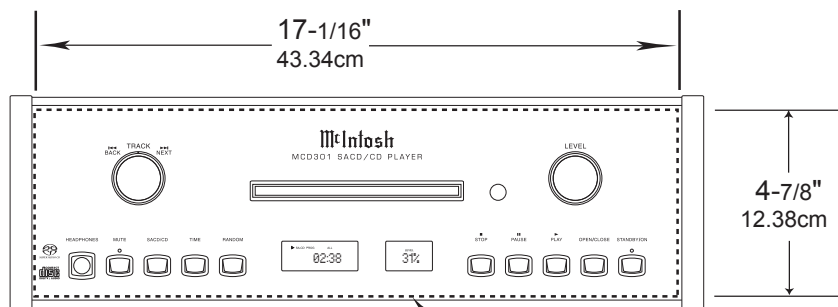

MCD301 Side View in Custom Cabinet

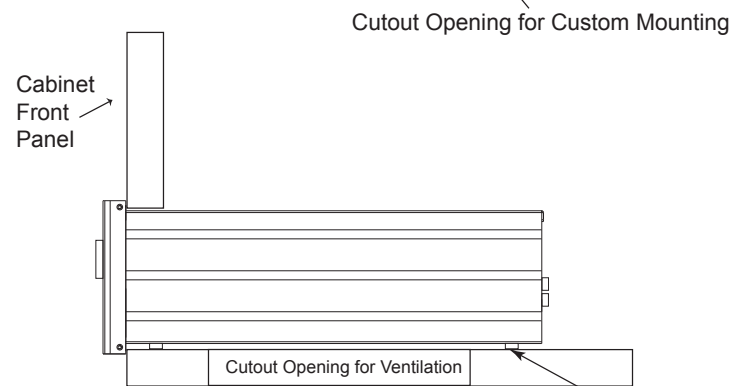

MCD301 Bottom View in Custom Cabinet

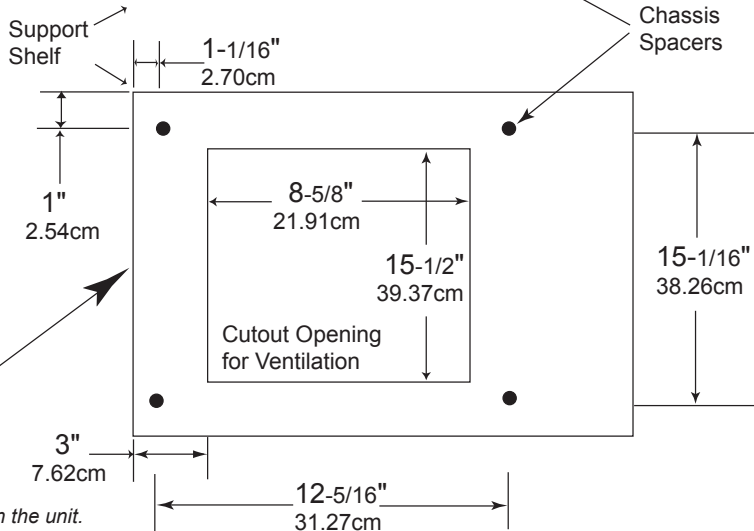

Note: Center the cutout horizontally on the unit. For purposes of clarity, the above illustration is not drawn to scale.

BALANCED VARIABLE level AUDIO OUTPUTS supply analog audio signals to connect to Balanced Inputs of other components

POWER CONTROL IN receives turn-on signals from a McIntosh component and POWER CONTROL OUT sends turn-on signals on to another McIntosh Component

COAXIAL DIGITAL AUDIO OUTPUT sends signals to a Control Center with a D/A Converter or a decoder

BALANCED FIXED level AUDIO OUTPUTS supply analog audio signals to Balanced Inputs of other components

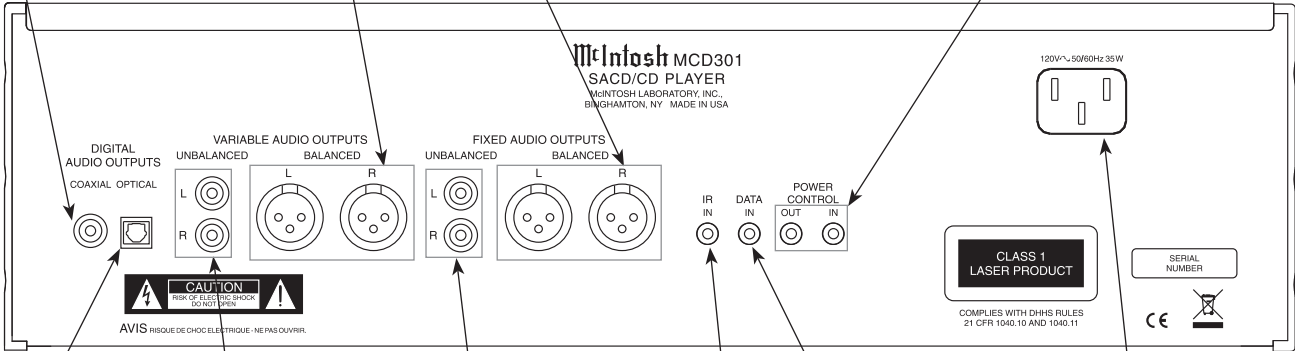

OPTICAL DIGITAL AUDIO OUTPUT sends signals to a Control Center with a D/A Converter or a decoder

UNBALANCED FIXED level AUDIO OUTPUTS supply analog audio signals to Unbalanced Inputs of other components

DATA IN receives operating data from a McIntosh Control Center

UNBALANCED VARIABLE level AUDIO OUTPUTS supply analog audio signals to Unbalanced Inputs of other components

IR INPUT for connecting an IR Receiver

Connect the MCD301 power cord to a live AC outlet. Refer to information on the back panel of your MCD301 to determine the correct voltage for your unit



How to Connect Control, Analog and Digital Audio

1. Connect a Power Control Cable from the MCD301 POWER CONTROL IN jack to the POWER CONTROL ACC Output jack of a McIntosh Preamp/Control Center.
2. Connect a Data Cable from the MCD301 DATA IN jack to the CD2 DATA jack on the McIntosh Preamp/Control Center.
3. Connect an Optical Cable from the MCD301 OPTICAL DIGITAL AUDIO OUTPUT to the CD2 Optical DIGITAL INPUT of a McIntosh Preamp/Control Center.

Note: An optional connecting method is to use a coaxial cable from the MCD301 COAXIAL DIGITAL AUDIO OUTPUT to the Coaxial Digital Input of a McIntosh Preamp/Control Center.

4. Connect XLR Cables from the MCD301 BALANCED-FIXED AUDIO OUTPUTS to the Balanced Inputs on a McIntosh Preamp/Control Center.
*Notes: 1. The Unbalanced Audio Outputs may be used instead of the Balanced Outputs.
2. The VARIABLE AUDIO OUTPUTS, Balanced or Unbalanced outputs, may used instead of the FIXED AUDIO OUTPUTS.*
5. Connect the supplied AC Power Cord between the MCD301 AC Power Cord Socket and a live AC outlet.

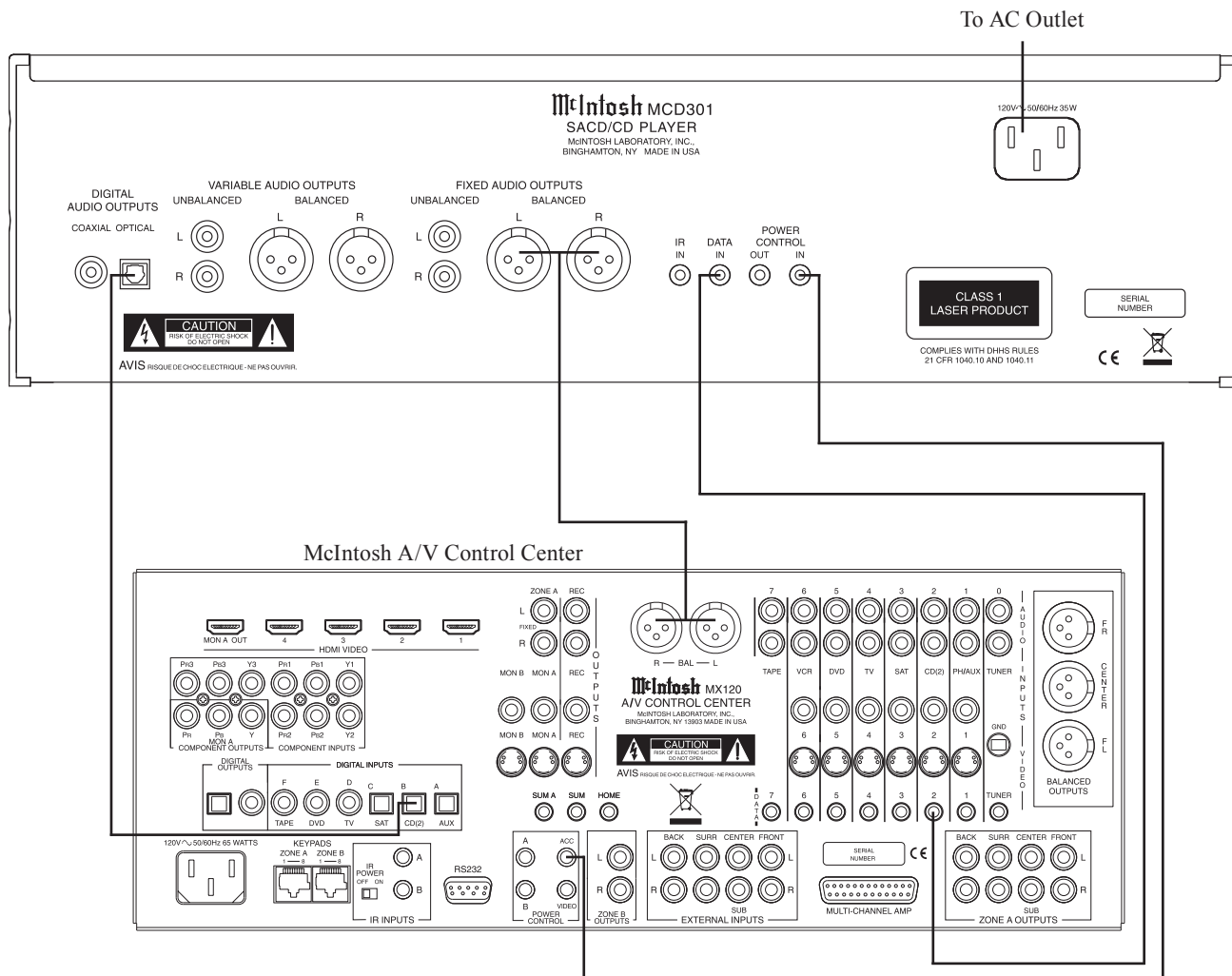

How to Connect Directly to a Power Amplifier

The MCD301 SACD/CD Player has Variable Output Connections and a Front Panel Level Control making it possible to form a high performance Disc Playback System. This system consists of a MCD301 directly connected to a McIntosh Power Amplifier.

1. Connect a Power Control Cable from the MCD301 POWER CONTROL OUT jack to the POWER CONTROL IN jack of a McIntosh Power Amplifier.
2. Connect XLR Cables from the MCD301 BALANCED VARIABLE AUDIO OUTPUTS to the Balanced Inputs on a McIntosh Power Amplifier.

Note: The Unbalanced Audio Outputs may be used instead of the Balanced Outputs.

3. Connect the supplied AC Power Cord between the MCD301 AC Power Cord Socket and a live AC outlet.

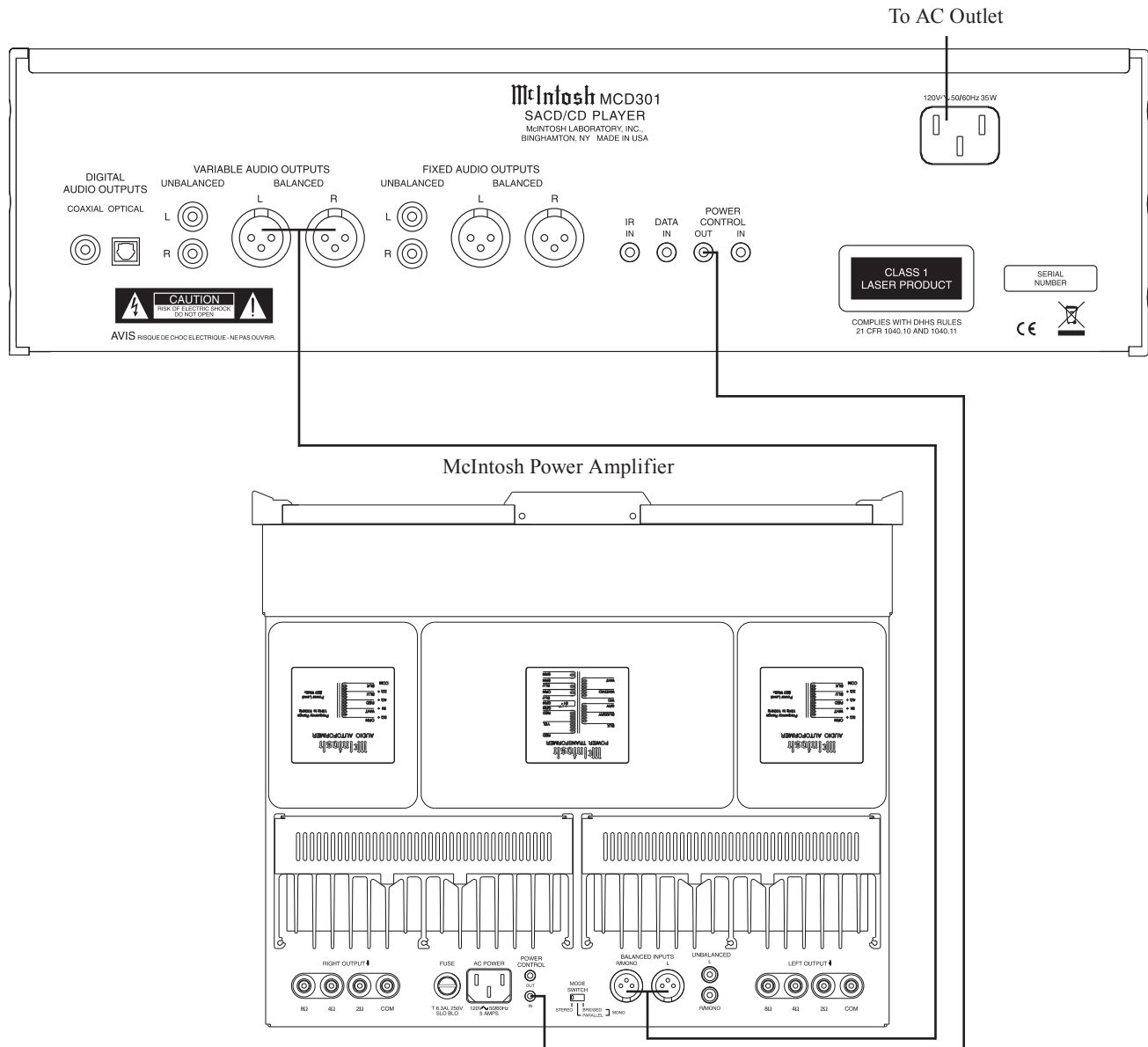



Front Panel Displays, Controls, Push-buttons and Jack

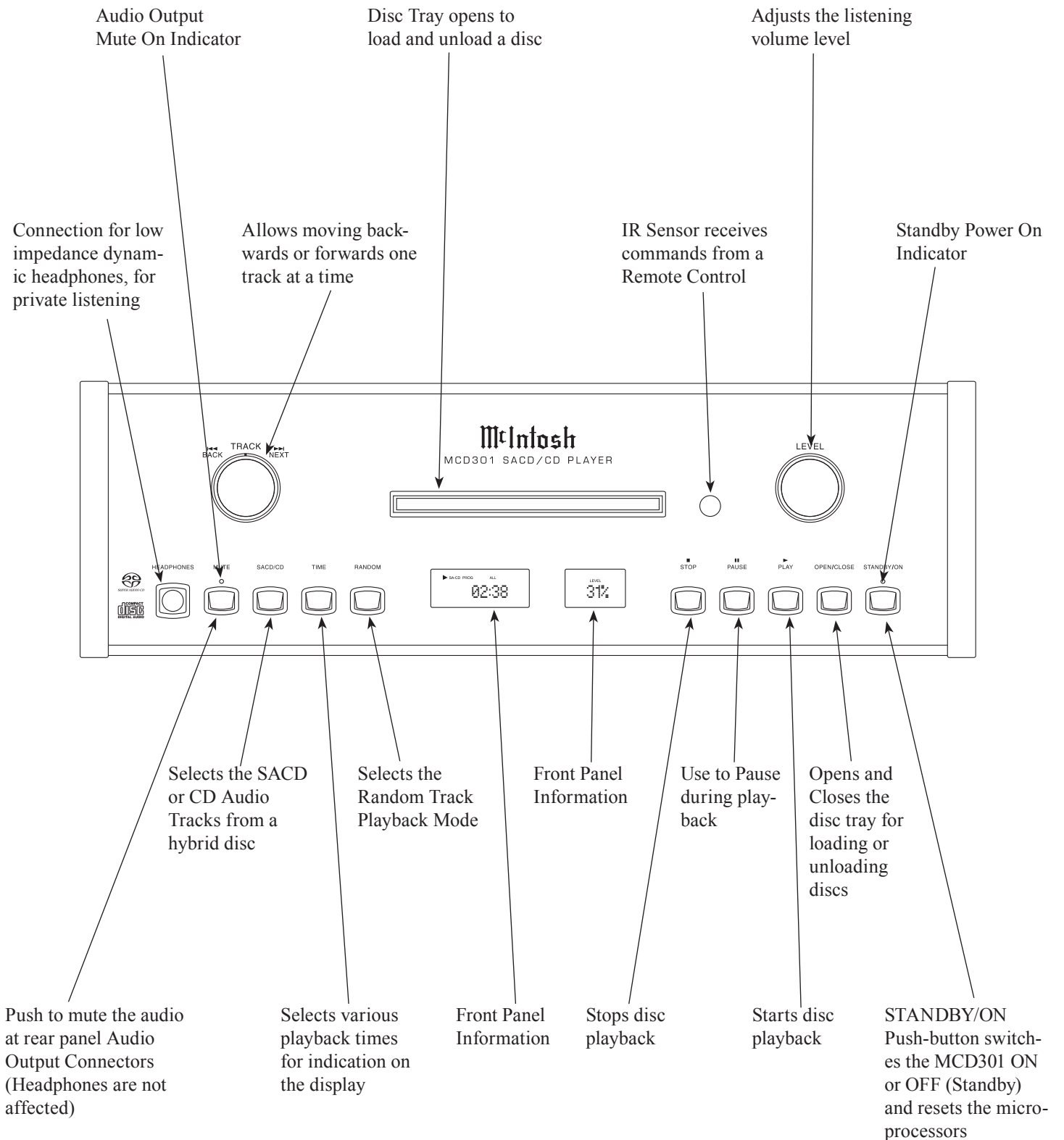

Indicates when in the Pause Mode

Indicates the Programming or Program Play Mode is active

Indicates the Repeat Mode selected; Repeat All (Tracks), Repeat 1 (Track) or Repeat from point A to point B in the selected Track

Indicates the volume level available at the variable outputs and headphone jack

Indicates the type of disc loaded, CD or SACD

Indicates the Random Play Mode is active

Indicates when the tracks on the CD disc are MP3 or WMA encoded

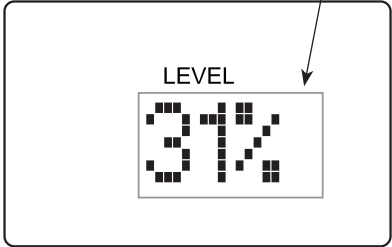
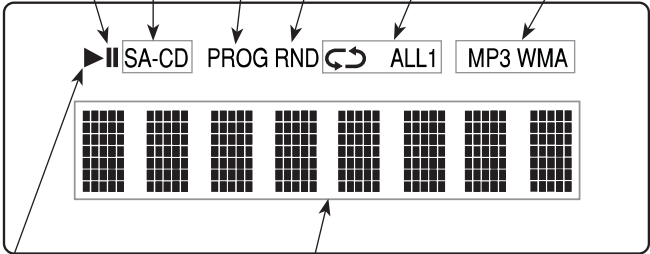

Indicates when the Play Mode is active

Indicates the number of tracks on the Disc, Programmed Tracks, the current Track Time, Remaining Track Time, Total Disc Playing Time, Text and various other Information

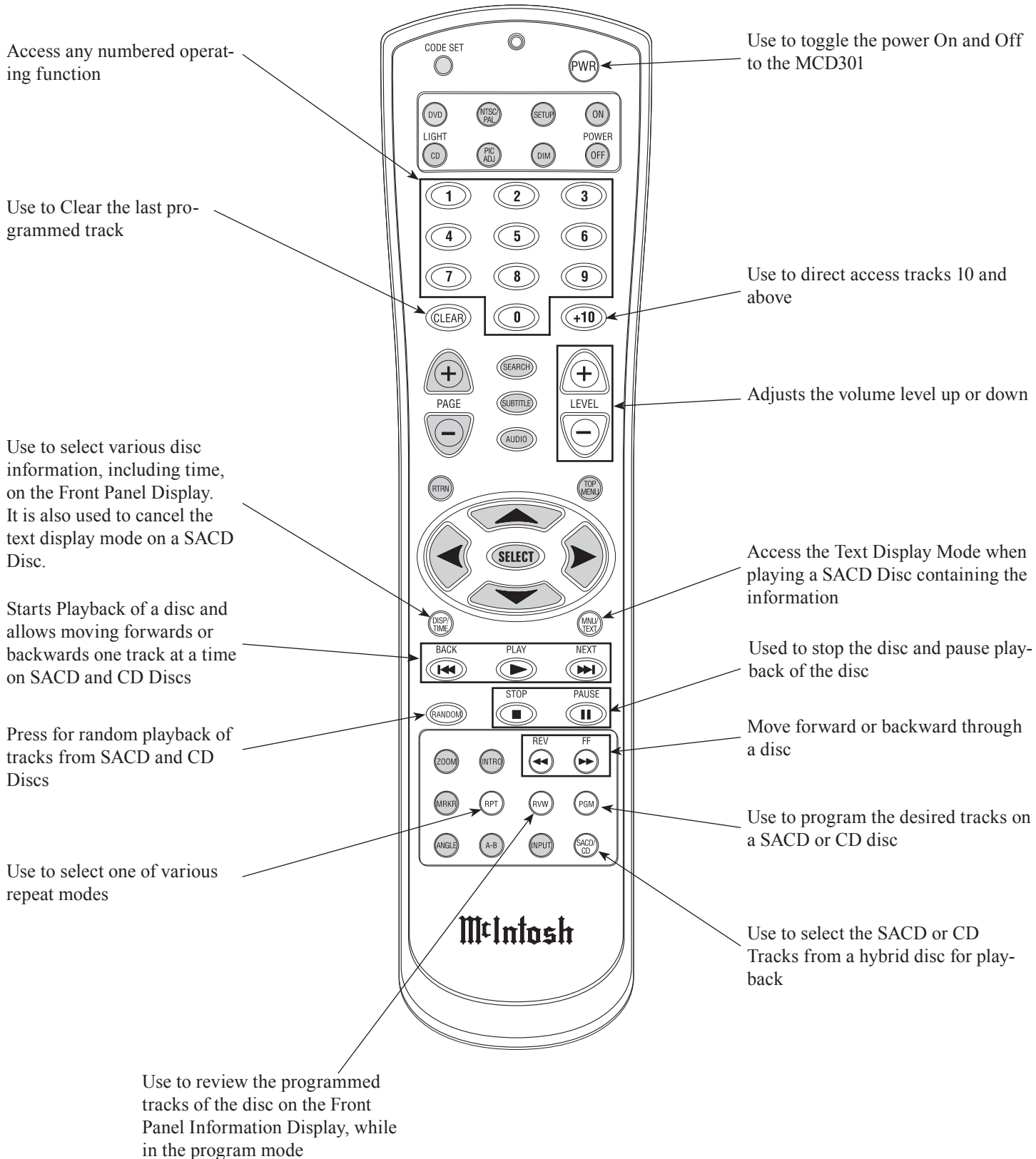

Note: The Remote Control Push-buttons with a "grayed background" are for use with other McIntosh Products.

How to use the Remote Control

The Remote Control is capable of performing basic Operating Functions for the MCD301 SACD/CD Player.

Notes: 1. Refer to the "How to Operate" Section of this manual for additional information using this Remote Control.

2. The translucent Remote Control Push-buttons will illuminate for approximately 3 seconds when activated.

Play

With a disc loaded, press the **PLAY ►** Push-button to start the disc playing.

Stop

Press the **STOP ■** Push-button to stop disc playback and return to displaying the table of contents of the disc.

Numbered Push-buttons

Press 1 through 9 to directly access one of the first nine Disc Tracks using the Front Panel Information Display. For track numbers greater than 10, press the **+10** Push-button followed by the 0-9 Push-button. For example, to access Disc Track 23, press the **+10** Push-button twice and then the **3** Push-button.

Pause

Press the **PAUSE ||** Push-button to temporarily stop disc playback at any time. Press the **PLAY ►** Push-button to resume playback.

REV and FF

Press the **REV (Reverse) ◀◀** or **FF (Fast Forward) ▶▶** Push-button to start moving rapidly through a track on the disc. When the desired location is reached release the **REV (Reverse) ◀◀** or **FF (Fast Forward) ▶▶** Push-button to resume normal playback.

Back and Next

Press the **NEXT ▶▶** Push-button to move forward one track or the **BACK ◀◀** Push-button to move back to the beginning of the current track playing.

Note: If the BACK ◀◀ Push-button is pressed during playback of the first three seconds of the track, the MCD301 will start playing back the previous track from the beginning. If the Front Panel Information Display is indicating time the display will momentarily indicate the track number.

SACD/CD

Press to select the SACD or CD Tracks from a hybrid disc for playback.

Display/Time

Press the **DISPlay/TIME** Push-button to access various disc times. It is also used to return the Front Panel Information Display to indicating time instead of text information on a SACD Disc.

Menu/Text

Press to select the various text information on a SACD Disc such as Album, Artist and Track Titles (disc dependent).

Repeat Modes

Press the **RPT (Repeat)** Push-button to select either One Track, All Tracks or cancel the Repeat Mode.

Program

Press the **PGM (Program)** to activate the Program Mode to playback only certain disc tracks in the desired order.

Review

Press the **RVW (Review)** Push-button to review the Programmed Tracks from the disc on the Front Panel Information Display, while in the Program Mode.

Clear

Press the **CLEAR** Push-button to erase a program track(s).



How to Operate the MCD301

Power On

The Red LED above the STANDBY/ON Push-button lights to indicate the MCD301 is in Standby mode. To Switch ON the MCD301, press the STANDBY/ON Push-button on the Front Panel or the PWR (Power) Push-button on the Remote Control. Refer to figures 6 and 16.

Note: When AC Power is initially applied to the MCD301 the unit will momentarily switch On and then go into the Standby Mode.

How to Load a Disc

1. Press the OPEN/CLOSE Push-button.

The disc tray will slide out allowing a disc to be loaded. Refer to figure 1.

2. Press the OPEN/CLOSE Push-button

and the disc tray will close. Refer to figures 6, 2, 3 and 5. Loading of disc's Table of Contents (number of tracks) will be indicated on the Front Panel Information Display.

When a SACD Disc is loaded the Front Panel Display will scroll the Album Title first and then display the number of tracks. Refer to figures 4 and 5.

Note: When a Disc is placed in the tray and the PLAY Push-button is pressed, the tray will close and the first track will start playing.

How to Play a SACD Disc

With a disc already loaded into the MCD301, press the PLAY ► Push-button on the Front Panel of the MCD301 or Remote Control. Refer to figures 6 and 16. The Disc will start playing the first track of the SACD Layer.

To change from the default SACD Layer to CD Layer,

press the SACD/CD Push-button (on the Front Panel or Remote Control) once to see the current selection and a second time to change the selection. Refer to figures 6, 7, 8 and 16.

The Player will load the CD Table of Contents (Number of tracks and Total Playing Time) at this time. To start playing the CD Layer press the PLAY ► Push-button.

Notes: 1. Changing between the SACD and CD Layer can be accomplished at any time by performing the above procedure.

2. The default setting for SACD/CD Hybrid is to play the SACD Layer. The default setting may be changed to play the CD Layer instead. With the MCD301 On and no disc loaded, press the SACD/CD Push-button until the Front Panel Display indicates CD. Refer to figures 6, 9, 7 and 8.

3. Some SACD Disc(s) have the ability of displaying the Album Title and Artist. With the disc loaded, SACD Table of Contents read and the **disc stopped**, press the MNU/TEXT Push-button once for scrolling the Title and twice for scrolling the Artist Name. Display of the Artist information is not available during playback of the disc. Refer to figures 10 and 11.

4. In a similar manner, some SACD Disc(s) have the ability of scrolling the Track Number and Title by pressing the MNU/TEXT Push-button **after** the Track has started to play. Refer to figure 12.



Figure 7



Figure 8



Figure 1



Figure 2



Figure 3



Figure 4



Figure 5



Figure 9



Figure 10



Figure 11

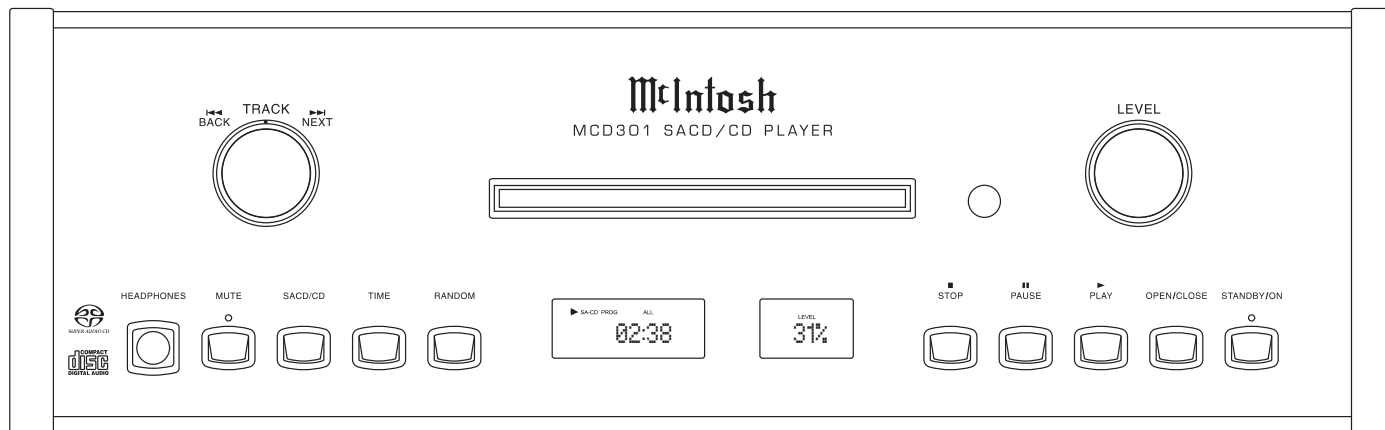

Figure 6

- The Text Display Mode may be canceled by pressing the DSP/TIME Push-button on the Remote Control. Refer to figure 16.



Figure 12

- One of the Track Time Modes may also be displayed instead of the Track Number, by pressing the DSP/TIME Push-button on the Remote Control. Refer to figure 13. For additional information on the Time Display Modes refer to "Display Modes" on page 19.



Figure 13

How to Play a CD Disc

With a disc already loaded into the MCD301, press the PLAY ► Push-button on the Front Panel of the MCD301 or Remote Control. Refer to figures 6, 14 and 16.



Figure 14

How to Pause a Disc

This feature allows for the temporary stopping of disc playback. Refer to figures 6, 15 and 16.

- When playing a Disc, press the PAUSE || Push-button to temporarily stop playback.
- Press the PLAY ► Push-button to resume playing the disc.



Figure 15

Track Back

Return to the beginning of the Track currently playing by rotating the MCD301 Front Panel TRACK BACK ◀◀ Control counterclockwise and then releasing the control or momentarily pressing the BACK ◀◀ Push-button on the Remote Control. Rotate and hold the TRACK BACK ◀◀ Control or press and hold the BACK ◀◀ Push-button for rapid selection of the desired previous Tracks. Refer to figures 6 and 16.

Track Next

Advance to the next Track by rotating the MCD301 Front Panel TRACK NEXT ▶▶ Control clockwise and then releasing the control or momentarily pressing the NEXT ▶▶ Push-button on the Remote Control. Rotate and hold the TRACK NEXT ▶▶ Control or press and hold the NEXT ▶▶ Push-button for rapid selection of the next desired Track. Refer to figures 6 and 16.

Fast Forward or Reverse

Using the Remote Control, press the FF (Fast Forward) ►► or REV (Reverse) ◀◀ Push-button to search back and forth rapidly through a Track on a disc. To return to normal playback release the same FF (Fast Forward) ►► or REV (Reverse) ◀◀ Push-button. Refer to figure 16.

Stop Mode

Press the STOP ■ Push-button at any time to stop Playback. To listen to the disc again, press the PLAY ► Push-button and playback will start from the beginning of the disc.

Volume Level

The MCD301 has both Fixed and Variable Output Level Connections. The Variable Output Level Connections (Rear Panel and Front Panel Headphone Jack) are controlled by the Front Panel Level Control and the LEVEL Push-buttons on the Remote Control. Refer to figures 6, 16 and 17. The Front Panel Volume Level Information Display will indicate the Volume Level from 0 - 100%.

Note: When the Volume Level is 81%, the Rear Panel Variable Outputs will be at the same volume level as the Fixed Outputs.



Figure 17

Mute

Press the MUTE Push-button to mute the audio (-50dB down in level) at both the Fixed and Variable Output Connections on the Rear Panel. Refer to figure 6. The LED above the MUTE Push-button will illuminate. Pressing the MUTE Push-button a second time restores the audio at the output connections and the LED will no longer be illuminated.

Note: The Headphone Jack is not affected by the Mute Function.

Direct Track Selection

The MCD301 Front Panel Display indicates the Disc Track currently playing. Use the Remote Control NUMERIC Push-button(s) to enter the desired Track Number. Refer to pages 14 and 15 for additional information using the Remote Control.

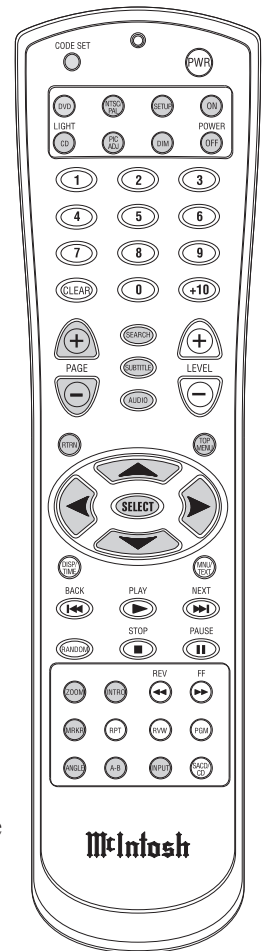

Figure 16

How to Operate the MCD301, con't

Repeat

This allows repeating a Track, Disc, Program Mode or Random Play Mode on a continuous basis. Refer to figures 6 on page 16 and 16.

1. With the disc playing (Regular, Program or Random Playback Modes), press the RPT (Repeat) Push-button once to activate the Track Repeat (↺ 1); press the RPT Push-button twice to activate the Disc Repeat (↺ All). Refer to figures 18 and 19.
4. To cancel the previously selected Repeat Mode, press the RPT (Repeat) Push-button until the word "1" or the word "ALL" in the Front Panel Information Display is extinguished.



Figure 18



Figure 19

Random Playback

This feature allows for listening to Tracks of a Disc in a Random Order. Refer to figure 6 on page 16 and figure 16.

Note: The MCD301 must be in STOP Mode with the Disc Loaded and the Table of Contents read before the Random Playback Mode Feature can be activated.

1. With the MCD301 in the STOP ■ Mode press the Random Push-button. The word RND (Random) will be indicated in the Information Display. Refer to figure 20.
2. Press the PLAY ► Push-button to start Random Playback. After all the tracks have been played the MCD301 will stop.

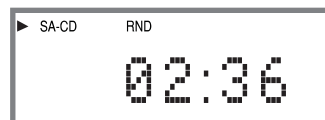

Figure 20

- Notes:*
1. To provide continuous playback of the disc, press the RPT Push-button twice to activate the Disc Repeat (↺ All) after the Random Playback Mode has started. If Repeat (↺ 1) is selected, the current track will repeat.
 2. The BACK TRACK function will begin playback from the beginning of the current track.
 3. The NEXT TRACK function will advance to the next random selection and start playing.
3. To cancel the Random Playback Mode, press the STOP ■ Push-button, then press the Random Push-button.

Program Playback

This feature allows for playback of selected Tracks on a Disc in the desired order. In the following example, a Disc

is programmed to play Track 6 followed by Track 4 and then Track 2.

- Notes:*
1. The MCD301 must be in STOP Mode with the Disc TOC (Table of Contents) read before the Program Playback Mode Feature can be activated.
 2. When programming Hybrid SACD Discs, first choose the layer (SACD or CD) so the correct TOC can be read, as some discs have different selections for the SACD and CD Tracks.

1. Press the PGM (Program) Push-button to access the Program Mode. Refer to figures 16 and 21.
2. Enter the first desired selection using the Numeric Push-buttons. Refer to figures 16 and 22.
3. In a similar manner, enter the remaining Tracks. Refer to figures 23 and 24.

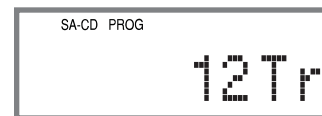

Figure 21

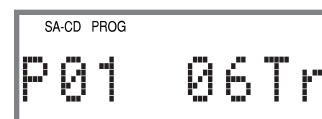

Figure 22

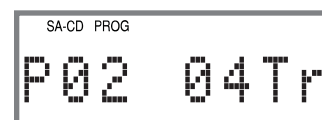

Figure 23

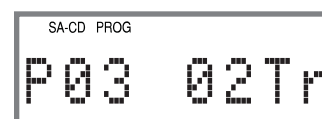

Figure 24

Note: To view and/or delete the selections programmed, use the REVIEW Push-button to step through programmed tracks and the CLEAR Push-button to remove any unwanted selections.

4. To start playback of the just entered program, press the PLAY ► Push-button. The Repeat Mode can be activated to provide continuous playback of the Programmed Track(s). Refer to figure 25.

Note: To momentarily stop playback, press the PAUSE || Push-button. To resume Program Playback press the PLAY ► Push-button.

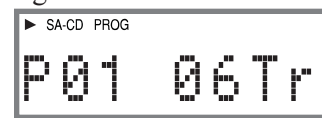

Figure 25

5. To cancel the Program Playback Mode press the STOP ■ Push-button followed by pressing the PGM (Program) Push-button.

Once the Program Playback Mode is active, tracks may be added or deleted by first pressing the STOP ■ Push-button followed by entering the additional tracks using the Numeric Push-buttons or deleting tracks by using the CLEAR Push-button. Press the PLAY ► Push-button to resume Program Playback Mode.

MP3/WMA Disc Playback

The MCD301 has the ability of playing back MP3 and

WMA encoded discs. MP3/WMA allow more tracks on the Disc by using the technique of lossy compression applied to the original audio information. The MP3/WMA Track has lower audio quality than the original recording. Load a MP3/WMA disc into the MCD301. Refer to figure 26.



Figure 26

1. Press the PLAY ► Push-button to start Playback. Refer to figure 27. After all the tracks have been played the MCD301 will stop.

Notes: 1. The MCD301 will indicate either elapsed time or remaining time for each track when playing MP3/WMA Discs.



Figure 27

2. When playing MP3/WMA

Discs, the left side of the Front Panel Information Display indicates the total number of folders on the disc followed by the Track Number or the Track Time.



Figure 28

Display Modes

The MCD301 Front Panel Information Display allows for either Track or Time indications. To change from the default setting of Track indication to Time, press the TIME Push-button on the Front Panel or the DISP/TIME Push-button on the Remote Control. Refer to figure 6 on page 16 and figure 16.

The Time Display Choices are Single Track Elapse Time (figures 29 and 30), Single Track Remaining Time (figures 31 and 32) or Total Tracks Remaining Time (figures 33 and 34).



Figure 29



Figure 30



Figure 31



Figure 32



Figure 33



Figure 34

Display Brightness

The MCD301 Front Panel Information Display has two brightness settings. To change from the default setting (brightest of the two) perform the following:

1. If the MCD301 is playing a disc press the STOP ■ Push-button.
2. Press and hold the PAUSE || Push-button until the brightness level of the two Front Panel Displays changes, then release the PAUSE || Push-button.

Note: Depending on the brightness setting before pressing the push-button, the intensity will go from high to low or low to high.

Resetting the MCD301

In the unlikely event the MCD301 stops functioning, the microprocessors can be reset by performing the following:

1. Press and hold in the STOP ■ Push-button for approximately three seconds. The Front Panel Display on the Left side will indicate "INITIAL", release your finger from STOP ■ Push-button. Refer to figure 35.
2. Press and hold in the STANDBY/ON Push-button for approximately five seconds. Refer to figure 6 on page 16.
3. When the STANDBY/ON LED is no longer illuminated, release the STANDBY/ON Push-button.
4. When the STANDBY/ON LED is illuminated press the STANDBY/ON Push-button, the MCD301 will resume normal operation.

Note: This can be performed with the MCD301 On or in the Standby Mode.



Figure 35

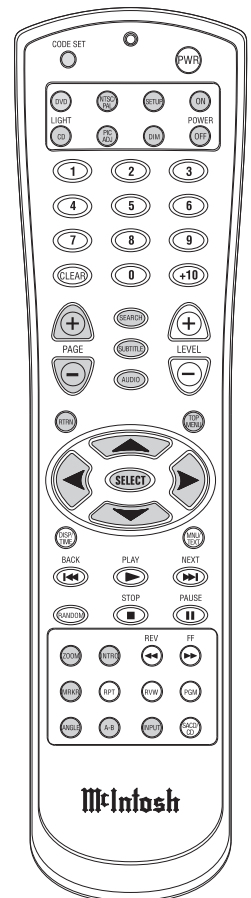

Figure 16



How to Operate the MCD301, con't

Operation in a McIntosh System

The MCD301 basic transport functions may also be controlled by using the Remote Control that comes with a McIntosh Control Center or Preamplifier. McIntosh Keypads can also be used to remotely control the basic transport functions of the MCD301. The labeling of Push-buttons on some McIntosh Remote Controls and Keypads are different from the supplied MCD301 Remote Control. Refer to the listing below and figures 36 and 37:

<u>MCD301 Remote Control Push-button</u>	<u>McIntosh Remote Control/Keypad Push-button</u>
Pause	E/Enter
SACD/CD	Review
Level Down	Channel/Seek Down
Level Up	Channel/Seek Up
+10	FM

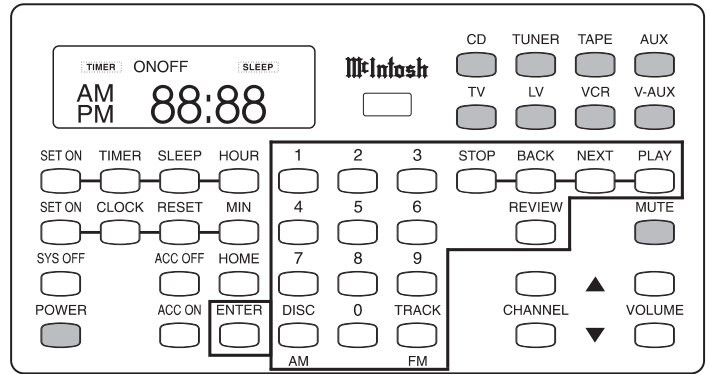

Figure 37

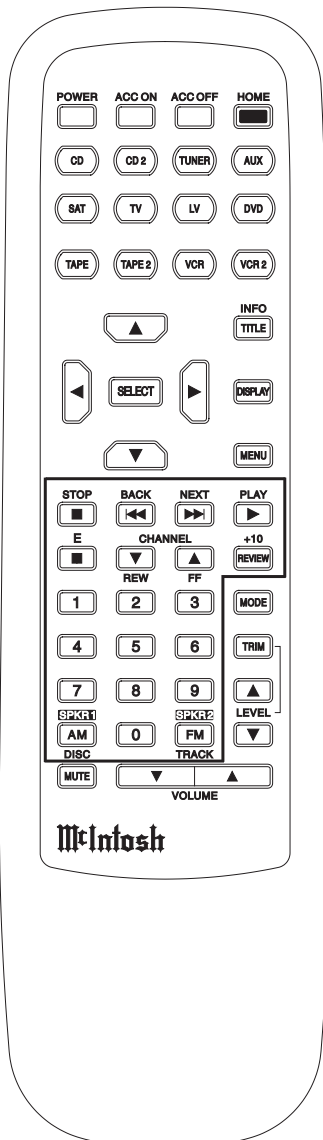
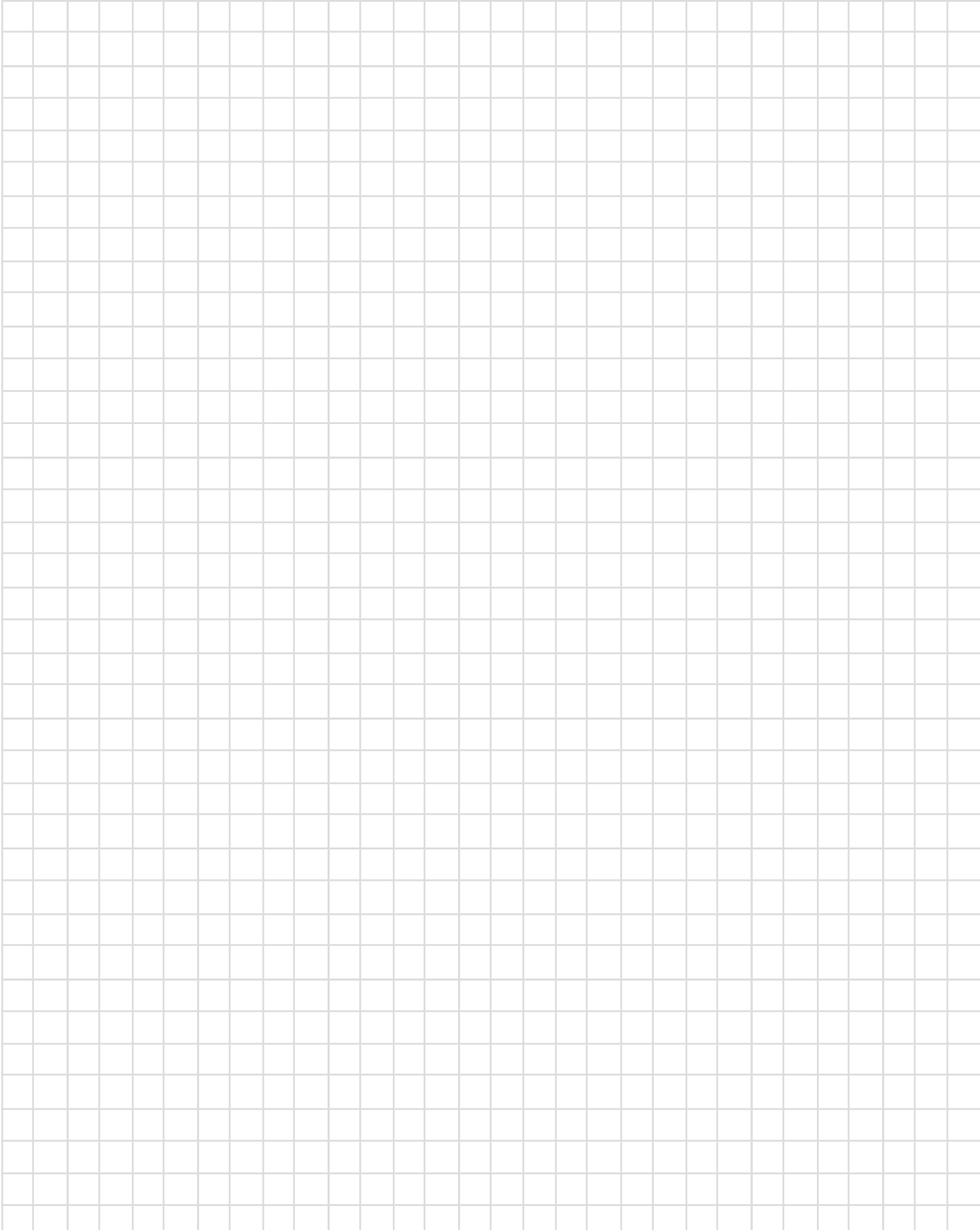

Figure 36





Audio Specifications

Fixed Output level

2.0Vrms Unbalanced

4.0Vrms Balanced

Variable Output level

0 - 6.0Vrms Unbalanced

0- 12.0Vrms Balanced

Output Impedance

600 ohms Unbalanced and Balanced

Frequency Response

4Hz to 40,000Hz, +0.5, -3dB (SACD)

4Hz to 20,000Hz, ±0.5dB (CD)

Signal to Noise Ratio

Better than 110dB (A-weighted)

Dynamic Range

Better than 100dB

Harmonic Distortion

0.002% @ 1000Hz (SACD)

0.003% @ 1000Hz (CD)

Channel Separation

Better than 98dB (1,000Hz)

General Specifications

Digital Output

Optical: - 15dbm to -21dbm (PCM)

Coaxial: 0.5V p-p/75 ohm (PCM)

Sampling Frequencies: 44.1kHz (PCM)

Transport

Laser Type: Twin Beam

Laser Beam Wavelength: 650nm (SACD)/790nm (CD)

Laser Power: CLASS IIa/CLASS I

Power Requirements

100 Volts, 50/60Hz at 35 watts

110 Volts, 50/60Hz at 35 watts

120 Volts, 50/60Hz at 35 watts

220 Volts, 50/60Hz at 35 watts

230 Volts, 50/60Hz at 35 watts

240 Volts, 50/60Hz at 35 watts

Standby: Less than 1 watt

Note: Refer to the rear panel of the MCD301 for the correct voltage.

Overall Dimensions

Width is 17-1/2 inches (44.45cm)

Height is 6 inches (15.24cm)

Depth is 16-1/2 inches (41.91cm)

Note: When the Disc Tray is opened, the panel clearance required in front of mounting panel is 6-3/4 inches (17.2cm).

Weight

28.2 pounds (12.8Kg) net, 44.6 pounds (20.2Kg) in shipping carton

Shipping Carton Dimensions

Width is 26-1/2 inches (67.3cm)

Depth is 24-1/4 inches (62.2cm)

Height is 11-3/4 inches (29.9cm)

Packing Instructions

In the event it is necessary to repack the equipment for shipment, the equipment must be packed exactly as shown below. It is very important that the four plastic feet are attached to the bottom of the equipment. This will ensure the proper equipment location on the bottom pad. Failure to do this will result in shipping damage.

Use the original shipping carton and interior parts only if they are all in good serviceable condition. If a shipping carton or any of the interior part(s) are needed, please call or write Customer Service Department of McIntosh Laboratory. Refer to page 4. Please see the Part List for the correct part numbers.

Quantity	Part Number	Description
1	033838	Shipping carton only
4	033837	End cap
1	033836	Inside carton only
1	033725	Top pad
1	034301	Bottom pad
4	017937	Plastic foot
4	400159	#10-32 x 3/4" screw
4	404080	#10 Flat washer

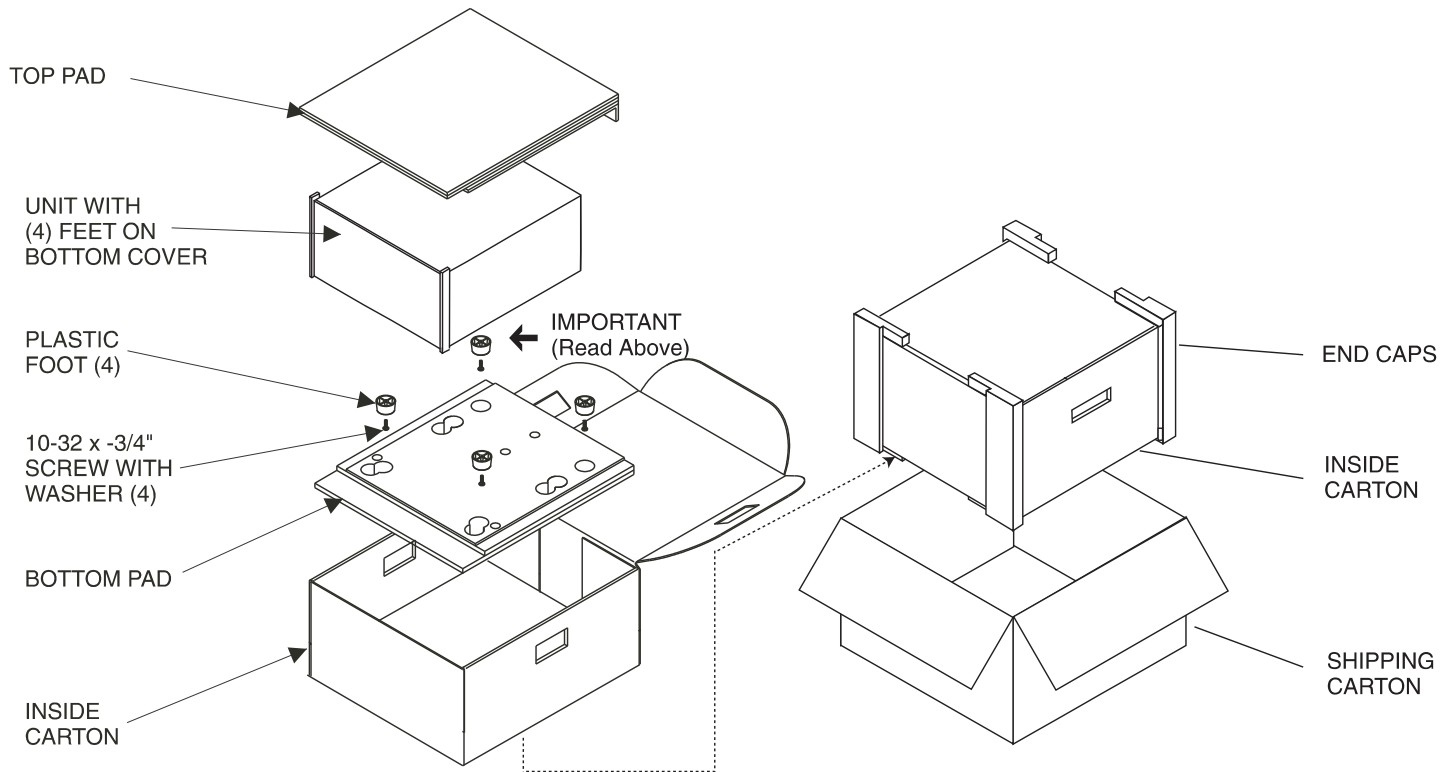



McIntosh Laboratory, Inc.
2 Chambers Street
Binghamton, NY 13903

The continuous improvement of its products is the policy of McIntosh Laboratory Incorporated who reserve the right to improve design without notice. Printed in the U.S.A.

McIntosh Part No. 04105900